



# **PRO 3600**

## **Owner's Manual**

# ***ATTENTION***

Your new digital protractor must be calibrated before use to ensure accurate readings. See your owner's manual for Superset<sup>®</sup> calibration instructions.

# ***WARNING***

**DO NOT PLACE BATTERY IN BACKWARDS**

## *Introduction*

The Pro 3600 Digital Protractor is a revolutionary measuring tool that provides an immediate, digital reading of all angles in a 360° circle. The machined aluminum frame is a rigid, light weight, ultra-precise platform that allows the state-of-the-art sensor and its microprocessor circuit to provide unsurpassed accuracy throughout the Protractor's 360° range.

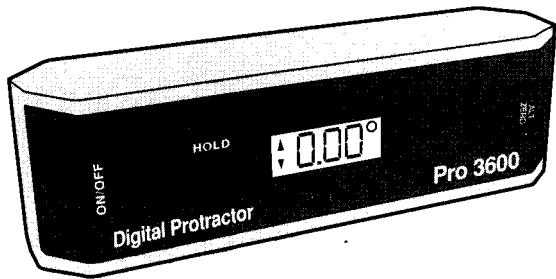

The Pro 3600 uses an innovative liquid filled angle sensor. As the protractor is moved, the liquid seeks a new position, resulting in changes in the electrical properties of the sensor. A microprocessor analyzes the changes and calculates the numbers seen on the display. The Pro 3600 also has an RS-232 compatible digital output which will interface with computers, data loggers and printers. This feature, along with the improved accuracy, high resolution and simple operation, makes the Pro 3600 a benchmark tool for years to come.

## Feature Overview

The Pro 3600 operates normally in a standard reference mode where *level* is displayed as  $0.00^\circ$ . However, a new reference point for  $0.00^\circ$  can easily be established by pushing the ALT ZERO button. You can also "freeze" any displayed angle on the LCD by pushing the HOLD button.

The  $360^\circ$  range of the unit is organized into four  $90^\circ$  quadrants for display purposes. Display resolution is  $0.01^\circ$  near level ( $0.00^\circ$  to  $9.99^\circ$ ) and  $0.1^\circ$  at all other angles ( $10.0^\circ$  to  $90.0^\circ$ ).

And the Pro 3600 does not need to be returned to the manufacturer or dealer for recalibration. By following the Superset<sup>®</sup> instructions in this booklet, you can test and recalibrate the Pro 3600 in just a couple of minutes on site and without any special fixtures.

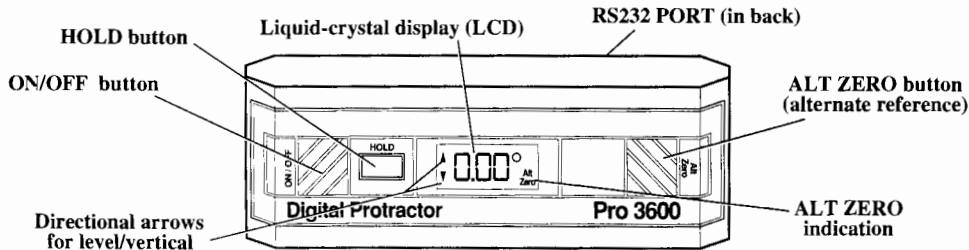

## ***Operating Instructions - Battery***

The Pro 3600 is powered by a 9-volt battery. A new alkaline battery will provide 500 hours of use. A 9-volt lithium battery can be used for even longer life.

To extend battery life, the Pro 3600 shuts off automatically when left undisturbed for five minutes (to reactivate, push the ON/OFF button) unless there is activity on the serial port. Note: Hooking serial port pin 5 (REQ) to pin 9 (BATT+) disables the auto-power shutoff.. The Pro 3600 also indicates when the battery is low. Change the battery when the display alternately flashes "LO bAt" with angle measurements. (**NOTE:** The Pro 3600 does not display inaccurate angles due to a weak battery.)

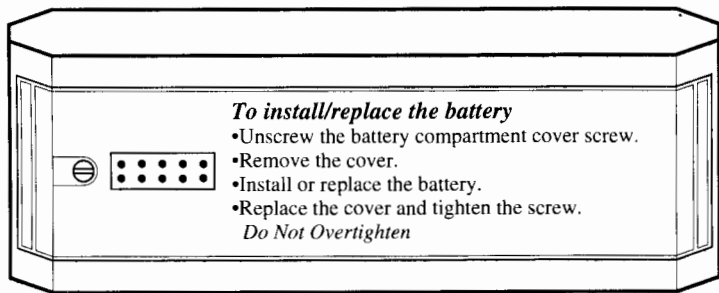

## ***Operating Instructions - Angle Measuring***

First, you must make sure your unit is reading accurately by using the test on pages 9-10. If the unit fails this simple test, you must recalibrate it using Superset® (pages 11-14).

To operate your Pro 3600, simply push the ON/OFF button; it will begin displaying angle readings immediately. Set the Pro 3600 on the surface to be measured and read the angle. (To get the most accurate reading, allow the unit to settle for 5 seconds before noting the angle.) The resolution will be one hundredths of a degree for  $\pm 10^\circ$  of level. The resolution will automatically change to tenths of a degree beyond these points.

When the unit is first turned on, the displayed angles will be in *standard reference mode* - level (true horizontal) is displayed as  $0.00^\circ$  and plumb (true vertical) is displayed as  $90.0^\circ$ . (An *alternate reference* point can be set easily if desired - see ALT ZERO.)

An arrow on the left side of the display will indicate which way to move the Pro 3600 to achieve level or plumb.

Between  $0^\circ$  and  $44.9^\circ$ , the arrow will point toward level. Between  $45^\circ$  and  $89.9^\circ$ , the arrow will point toward vertical (plumb).



## ***HOLD*** (temporarily "freezing" a reading on the display)

If you need to take a measurement with the Pro 3600 in an unreadable position, or if you need to temporarily lock in a reading while you record it, simply press the Hold button while measuring the angle. (Make sure the unit has been in position and still for 5 seconds.)

The readout will freeze and the decimal point, degree sign and an arrow on the left side of the LCD will flash.

To release, press the Hold button again.

**Note:** *The Pro 3600 cannot be recalibrated (Superset®) nor can a new reference point be established (ALT ZERO) when the HOLD feature is engaged. The HOLD feature is disengaged automatically when the unit shuts off or is turned off.*



## ***ALT ZERO (Setting an alternate reference point)***

ALT ZERO allows you to set any angle as a  $0.00^\circ$  reference point from which to take measurements.

To set an alternate reference point, place the Pro 3600 on the new surface and wait 5 seconds. Press the ALT ZERO button once. "Alt" will appear on the display, followed by "-0-". The Pro 3600 will then display angles using the new reference. ALT ZERO will appear in the lower right hand corner of the display as long as the Pro 3600 is in ALT ZERO mode.

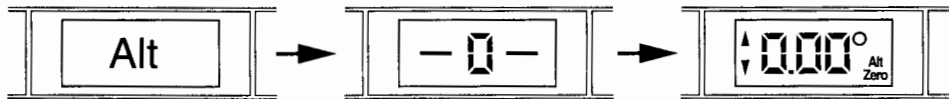

Press ALT ZERO again to return to standard reference mode. The Pro 3600 also returns to standard reference when it is turned off or shuts off automatically.

*NOTE: You cannot activate the ALT ZERO button when the Pro 3600 display is in HOLD.*

## Pro 3600 Serial Port

The Pro 3600 has an ASCII-format RS-232 compatible serial port for remote angle readout. The T&B Ansley 609-1027 connector on the back of the Pro3600 mates with industry standard cables. Angles are calculated and transmitted every 8/15 second (533 msec).

Pin assignments:

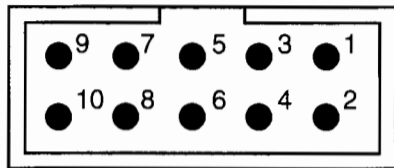

<u>Pin Number</u>	<u>Signal</u>	<u>I/O</u>	<u>Description</u>
1	GND	N/A	Signal Ground.
2	TD	Output	Transmits serial data bits (9600 baud, one stop bit, no parity). Hi impedance except during transmission bursts.
5	REQ	Input	RS-232 input; high signal requests data output.
9	BATT+	Either	Power input, or output if battery is installed in unit.
3, 4, 6-8, 10			Unused.

If REQ is high when power is applied or the unit is turned on, and it remains high, an output occurs every 8/15 second. If REQ is ever low or floating and the unit is on, outputs occur as a result of subsequent low-to-high transitions on REQ, provided REQ remains high for at least 100 msec. The output rate does not exceed one every 8/15 second.

## *DC Electrical Characteristics:*

<b>Parameter</b>	<b>Min.</b>	<b>Nominal</b>	<b>Max.</b>	<b>Unit</b>
REQ Input low voltage	-25	—	0.4	volts
REQ Input high voltage	2.4	—	25	volts
REQ Input resistance	3	5	7	k $\Omega$
TD Output low voltage	—	-5	—	volts
TD Output high voltage	—	+5	—	volts
BATT+ Input voltage	4.25	9	10	volts

## *Angle Output Format:*

The ASCII angle output may be read by a computer, or may directly drive a printer. Measured angles cover a full 360° range and the readout is between -180.00° and +180.00°.

Format:

<sign> XXX.XX <carriage return><line feed>

examples:

+ 124.50  
 + 32.70  
 + 9.38  
 - 4.32  
 - 179.99

## ***Recalibration***

Like all measurement instruments the Pro 3600 must periodically be monitored for accuracy. The Pro 3600 should be tested daily with the simple procedure outlined below. If it is found to be out of calibration, it is easily recalibrated on site using Superset® - an eight-step procedure that realigns the unit through its entire 360° range and takes just a couple of minutes to perform. And Superset® doesn't require any special fixtures, tools, or expertise.

## **Accuracy Test**

**Perform this simple test each day before using the Pro 3600. Also perform it anytime the Pro 3600 has been dropped or is being used in an environment that varies more than 5° C (9° F) from the environment in which it was last calibrated. *If your Pro 3600 fails this test, you must recalibrate it using Superset® before using the unit further to measure angles.***

- Position the Pro 3600 with the display facing you on a clean, flat horizontal surface. It doesn't have to be exactly level. Wait 10 seconds so the unit is completely settled and note the angle on the display.

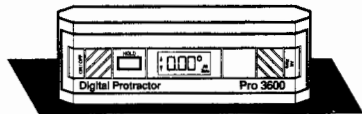

- Rotate the unit end-for-end so the display is facing away from you. Be sure to set the Pro 3600 in exactly the same spot, and wait 10 seconds before reading the angle that's displayed.
- Now roll the unit toward you so that the display is facing you, but the lettering on the face of the unit is upside down. Wait 10 seconds, and note the angle on the display.
- Finally, rotate the unit end-for-end so the display is facing away from you (the lettering should still be upside-down). Wait 10 seconds and note the angle on the display.

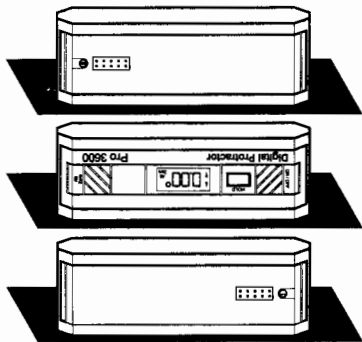

- **If any of the four measurements varies from any other by more than  $0.1^\circ$ , you must recalibrate (Superset<sup>®</sup>) your unit before using it further.**

## Superset<sup>®</sup>

Superset<sup>®</sup> recalibrates the Pro 3600 through its entire 360° range by electronically recording four horizontal and four vertical settings. It should be performed whenever the accuracy test shows a discrepancy of 0.1° or more.

### *How to Perform Superset<sup>®</sup>*

Turn on the Pro 3600 and place it on a flat surface. You can use any horizontal surface within 10° of level and any vertical surface within 10° of plumb to perform Superset<sup>®</sup>. You must use the same surfaces throughout the entire process.

*Note: Each time you reposition the Pro 3600 during Superset<sup>®</sup>, wait a minimum of 10 seconds before pressing the HOLD button to advance to the next step.*

### *Starting Superset<sup>®</sup>*

- Press and hold the HOLD and ALT ZERO buttons simultaneously. Keep them depressed for approximately three seconds.
- Release the buttons when the symbol "SUP" appears. A "0" within flashing brackets will then appear. These brackets are composed of four horizontal and four vertical segments.

*Note that as you proceed through the eight steps of Superset<sup>®</sup>, a new segment will hold steady after you complete each step.*



"0" within flashing brackets

## Superset® - Horizontal Settings

- [1]
- Unit faces you and white lettering on face is right-side up.
  - Align with an edge or line - wait 10 seconds.
  - Press HOLD button until [ 1 ] appears.

- [2]
- Rotate unit so it faces away from you, the lettering should still be right-side up.
  - Align with same edge or line - wait 10 seconds.
  - Press HOLD button until [ 2 ] appears.

- [3]
- Roll unit so it faces you, the lettering should now be upside-down.
  - Align with same edge or line - wait 10 seconds.
  - Press HOLD button until [ 3 ] appears.

- [4]
- Rotate unit so it faces away from you, the lettering should still be upside-down.
  - Align with same edge or line - wait 10 seconds.
  - Press HOLD button until [ 4 ] appears.

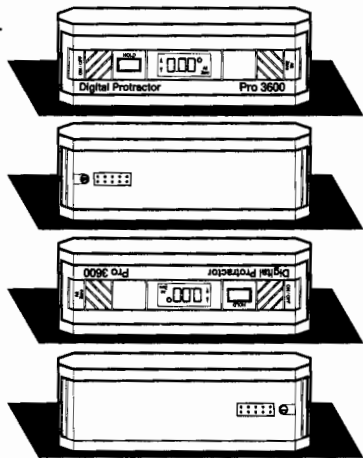

*You have completed one half of Superset® (continued on next page)*

## Superset® - Vertical Settings

[5]

- Place unit against vertical surface so it faces you, the lettering on the face ("Pro 3600, etc.) should read from bottom to top.
- Align with an edge or line - wait 10 seconds.
- Press HOLD button until [ 5 ] appears.

[6]

- Roll the unit so it faces away from you, the lettering should still read from bottom to top
- Align with same edge or line - wait 10 seconds
- Press HOLD button until [ 6 ] appears.

[7]

- Rotate unit end-for-end so it faces you, the lettering should now read top to bottom.
- Align with same edge or line - wait 10 seconds
- Press HOLD button until [ 7 ] appears.

[8]

- Roll the unit so it faces away from you, the lettering should still read top to bottom.
- Align with same edge or line - wait 10 seconds
- Press HOLD button. [ 8 ] will very briefly appear, followed immediately by regular angle measuring.



Pro 3600



Pro 3600



Pro 3600

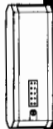

Pro 3600

*Your Pro 3600 has been Superset® back to manufacturer's spec's.*

### ***Canceling Superset®***

You may cancel Superset® at any time during the process by turning the unit off.

## ***Maintenance***

The Pro 3600 is designed to stand up to the rigors of industrial use. The following tips will ensure a long service life:

- Use the "end-for-end" accuracy test daily to make sure the unit is in calibration. If it is not, recalibrate it immediately with Superset®.
- Clean the Pro 3600 with mild liquid soap and a damp cloth. Never immerse in water.
- Do not use solvents directly on any of the Pro 3600 plastic surfaces.
- Store the Pro 3600 away from extreme temperature: Never below -20°C (-4°F) or above 65°C (149°F).

## Pro 3600 Specifications

Range .....	360° (90° x 4)
Resolution .....	0.01° (0° to 9.99°) 0.10° (10° to 90°)
Accuracy .....	±0.05° (0° to 10°) ±0.10° (80° to 90°) ±0.20° (10° to 80°)
Repeatability .....	±0.05°
Cross Axis Error ..	Minimal

## Serial Port

Type .....	RS-232 Compatible
Connector .....	10-pin, Rectangular
Supply Voltage .....	9 V. Alkaline Battery
Battery Life .....	500 hours typical

## Temperature

Operating ..	-5°C to 50°C (23°F to 122°F)
Storage .....	-20°C to 65°C (-4°F to 149°F)

Weight..... 295 g. (10.4 oz.)

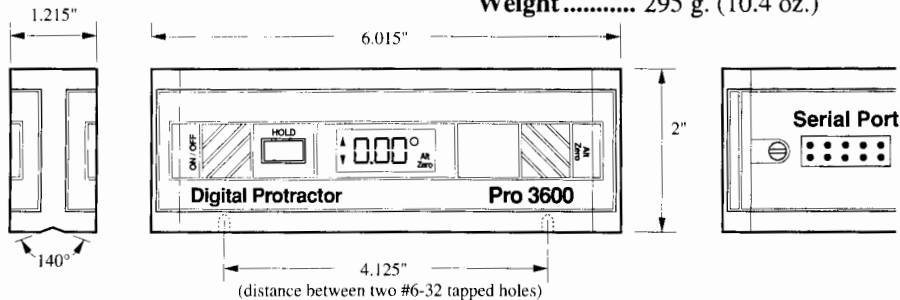

## ***One-Year Limited Warranty***

If, within one year from the date of original purchase, the Pro 3600 Digital Protractor fails to function because of defects in materials or workmanship, the manufacturer will, at its option, either repair or replace such components provided the original purchaser:

1. Contacts the dealer from whom the unit was purchased for instructions;
2. Follow the dealer's instructions for return of the unit;
3. Submit original date and proof of purchase;
4. Includes a brief explanation describing why the Pro 3600 Digital Protractor is inoperable, or how it was damaged.

This warranty does not cover damage resulting from accident, misuse or abuse, water, tampering, servicing performed or attempted by unauthorized agencies, units that have been modified in any fashion, or units that have not been recalibrated and maintained in accordance with the instructions in this manual.

If the components do not perform as warranted herein, the original purchaser's sole remedy will be the repair or replacement of the components as provided above. In no event will the manufacturer be liable for damages, lost revenue, lost wages, lost savings, or any other incidental or consequential damages, domestic or international, rising from the purchase and use or inability to use the components even if the manufacturer has been advised of the possibility of such damages.

Except as provided herein, the manufacturer makes no warranties, express or implied, including without limitation, the implied warranties of merchantability and fitness for a particular purpose, with respect to the components. All warranties for the components, express or implied, are limited to the warranty period set forth above. Some states do not allow limitations on how long an implied warranty lasts or the exclusion or limitation of incidental or consequential damages, so the above limitations or exclusions may not apply to you.

This warranty gives you specific legal rights. You may also have other rights, as indicated above, which vary from state to state.